

DragonROV

Intelligent Subsea Equipment

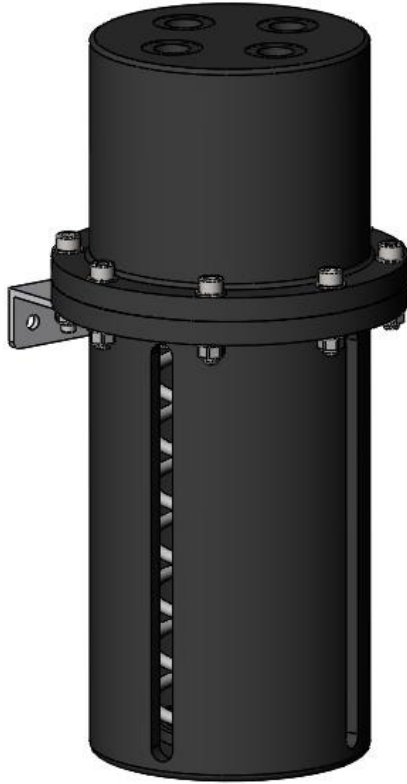

Description:

Rolling bladder type compensator for pressure balancing of subsea oil filled assemblies such as junction boxes, transformer housings, or motor bodies. Standard design manufactured from lightweight corrosion resistant Acetal for general purpose use.

Hydraulic Compensator 2130cc version

MAIN FEATURES

- Corrosion resistant
- 2130cc volume
- Compensates a volume of up to 14260cc
- Acetal body with rubber diaphragm and stainless steel spring

Further Information

Advanced spares kits also available

Equipment supplied

Standard supply includes

- 2130cc compensator unit.
- Operating manual



info@DragonROV.com

Specifications

Weight in Air	2.6Kg
Weight in Sea water	0.6Kg

Options

- Aluminium, Stainless steel, and duplex versions available

Information contained in this data sheet is up-to-date and correct as at the date of issue. All product designs, specifications and data are subject to change without notice to improve reliability, function, design or otherwise. No express or implied warranties are given.